

EVOENERGY LOW VOLTAGE EMBEDDED GENERATION TECHNICAL REQUIREMENTS

Technical requirements for connection of low voltage embedded generating units to the Evoenergy network

CONTENTS

1. INTRODUCTION	4	4.10 Power Quality	24
1.1 About Evoenergy	4	4.10.1 Quality of Supply & Generation	24
1.2 Scope and Purpose	4	4.10.2 LV EG IES Power Quality Response Modes	24
1.3 Obligations	6	4.10.3 LV EG Non-IES Power Quality Response	25
1.4 Statement of Compliance	6	4.11 Communication Systems	25
2. DEFINITIONS AND ABBREVIATIONS	6	4.11.1 LV EG IES less than or equal to 200 kVA (Excluding ESS) Communications Systems	25
2.1 Definitions	6	4.11.2 LV EG IES greater than 200 kVA (Excluding ESS) Communications Systems	25
2.2 Abbreviations	10	4.11.3 LV EG Non-IES Communication Systems	29
2.3 Terminology	11	4.12 Data and Information	29
2.3.1 Subcategories	12	4.12.1 Static Data and Information	29
3. RELEVANT RULES, REGULATIONS, STANDARDS AND CODES	13	4.12.2 Dynamic Data and Information	29
3.1 Evoenergy Documents	13	4.13 Cyber Security	30
3.2 Standards and Codes	13	4.14 Technical Studies	30
3.3 Legislation and Regulation	15	5. TESTING AND COMMISSIONING	31
4. TECHNICAL REQUIREMENTS	16	6. FEES AND CHARGES	33
4.1 Labelling and Signage	16	7. OPERATIONS AND MAINTENANCE	34
4.2 Maximum System Capacity	17	VERSION CONTROL	35
4.3 Generation Control	17	APPENDIX A – DEVIATIONS FROM THE NATIONAL DER CONNECTION GUIDELINES	35
4.3.1 Export Limits at Connection Point	17	APPENDIX B – CONNECTION ARRANGEMENT REQUIREMENTS	38
4.3.2 Site Generation Limit Downstream of Connection Point	17	APPENDIX C – MODEL STANDING OFFER	41
4.4 Inverter Energy System	17	APPENDIX D – STATIC DATA AND INFORMATION	41
4.5 Network Connection and Isolation	18	APPENDIX E – NETWORK TECHNICAL STUDY INFORMATION	42
4.5.1 Shared Generation	18		
4.6 Earthing	18		
4.7 Protection	19		
4.7.1 Inverter Integrated Protection	19		
4.7.2 Central Protection	20		
4.7.3 Interlocking	23		
4.7.4 Power Factor Control	23		
4.7.5 Synchronisation	23		
4.7.6 Additional Requirements for LV EG Non-IES	24		
4.8 Operating Voltage and Frequency	24		
4.9 Metering	24		

Disclaimer

Whilst this document contains material relevant to the electricity industry legislation, codes of practice and standards, it is not intended to provide legal advice on how electrical contractors can meet their own statutory obligations or comply with legislation, codes of practice or industry standards such as AS/NZS 3000 (Wiring Rules). Whilst care has been taken in the preparation of this document, Evoenergy does not guarantee that the information contained in this document is accurate, complete or up to date at time of publication. To the extent permitted by the relevant legislation Evoenergy will not be responsible for any loss, damage, cost or expense incurred as a result of any error, omission or misrepresentation in relation to the information contained in this document.

Note

Printed versions of this document are “uncontrolled copies” - the latest version is available on the [Evoenergy website](#).

1. INTRODUCTION

1.1 About Evoenergy

Evoenergy own and operate the electricity and gas distribution networks in the ACT, providing electrical power to over 200,000 residential and business customers. The electricity network delivers this power through 2,394 km of overhead lines, 2,694 km of underground cables, over 50,000 poles and over 5000 distribution substations across a geographical area of 2,358 square kilometres.

The Evoenergy network currently connects to more than 25,000 embedded generation systems, the majority of which are solar photovoltaic (PV) systems.

Evoenergy maintain and operate the network in compliance with relevant regulatory, technical and safety requirements. These requirements are adhered to in the long term interests of consumers particularly with respect to the price, quality, safety, reliability and security of the electricity supply system.

1.2 Scope and Purpose

Evoenergy has developed these technical requirements to provide proponents of Low Voltage Embedded Generator connections information about their obligations for connection to, and interfacing with, Evoenergy's low voltage distribution network. As outlined in Figure 1, this document is one of three documents defining the technical requirements for the connection of embedded generators to the Evoenergy network. These documents supersede the existing *Evoenergy Requirements for Connection of Embedded Generators up to 5MW to the Evoenergy Network (SM3201)* for the defined system capacities.

FIGURE 1. EVOENERGY EMBEDDED GENERATION DOCUMENT ARCHITECTURE

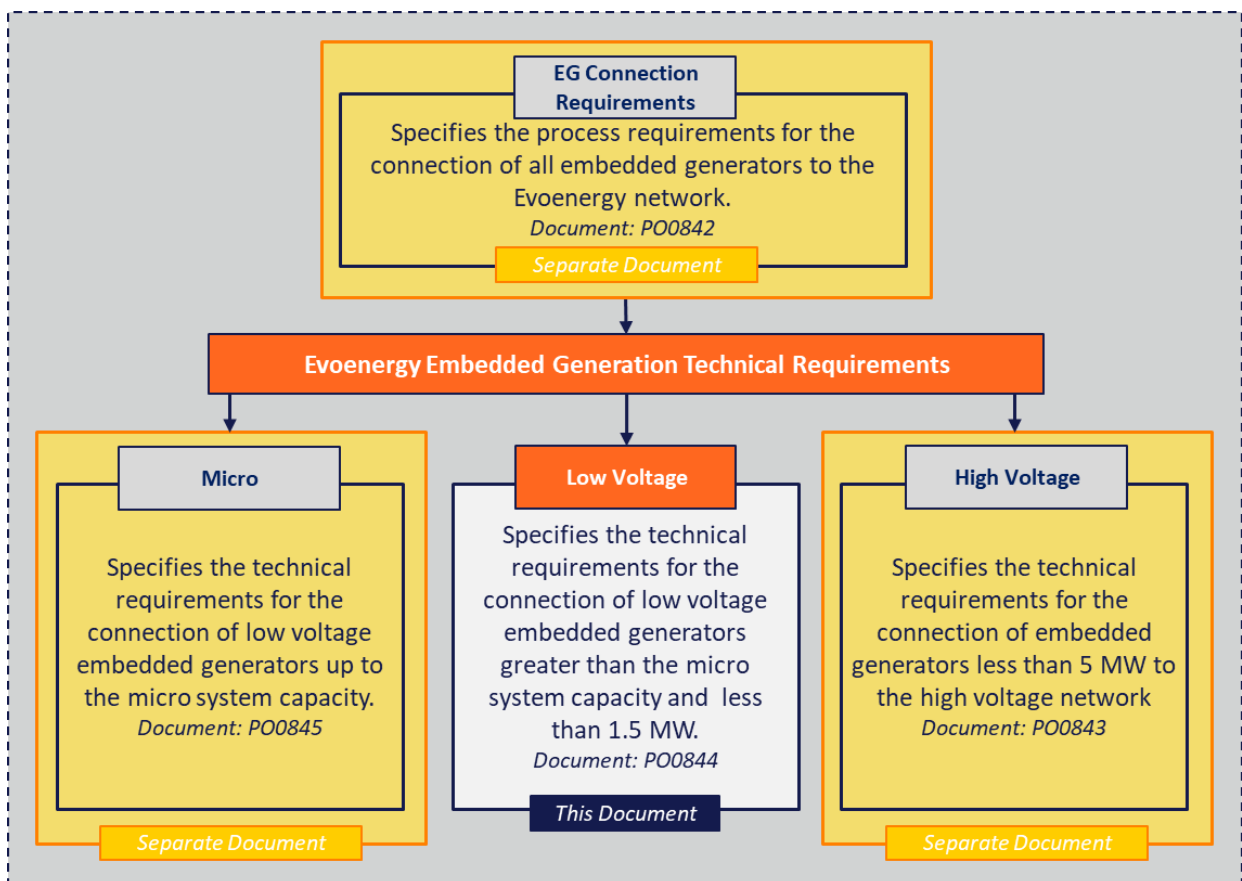

For the purposes of this document, a Low Voltage Embedded Generator is defined as:

an LV EG system with a total system capacity less than or equal to 1.5 MVA for a three-phase IES (excluding ESS) network connection that is:

- a. intended to be connected to, and capable of operating, in parallel with any part of the LV distribution network*
- b. meeting all other technical requirements set out in this document*





OR

an LV EG system with a total system capacity of greater than 0 kVA and less than or equal to 50 kVA for a single-phase or less than or equal to 1.5 MVA for a three-phase non-IES (synchronous or asynchronous) network connection that is:

- a. intended to be connected to, and capable of operating, in parallel with any part of the LV distribution network*
- b. meeting all other technical requirements set out in this document*

All Low Voltage Embedded Generators are subject to the requirements outlined in this document unless formally advised in writing by Evoenergy. These requirements are applicable to all new connections and modifications of existing systems where the system consists of an Inverter Energy System (IES), Energy Storage System (ESS), synchronous generators, asynchronous generators or any combination these categories.

Embedded Generators that are outside the scope of these requirements include:

-  Systems covered by the Evoenergy Micro EG Connection Technical Requirements
-  Systems covered by the Evoenergy HV EG Connection Technical Requirements
-  Electric vehicles, unless the on-board battery storage system is capable of exporting to the LV network (in which case the requirements shall apply)
-  Distributed energy resource systems that do not generate electricity including demand response / demand management systems, unless they impact on the ability of the LV system to meet the technical requirements
-  Systems that are off-grid or operate in a non-parallel configuration

This document does not administer the eligibility for any feed-in-tariff or any other tariff. The requirements set out in this document shall be read in conjunction with the Evoenergy Service and Installation Rules which are located on the Evoenergy [website](#).

This document contains technical requirements for the connection of LV embedded generators to the Evoenergy network. Additional information regarding the connection process and associated timelines is available on the Evoenergy [website](#).

1.3 Obligations

Embedded Generation Proponents and Evoenergy have certain obligations to ensure the purpose of these requirements is met. Proponents are required to:

- ☑ Comply with the technical requirements as well as relevant national standards, industry codes, legislation and regulations. In the event of inconsistency legislation and regulations, followed by the technical requirements, followed by national standards and industry codes shall prevail
- ☑ Withhold from connecting additional inverters, undertaking system modifications or installing additional micro embedded generation units, including ESS, without prior written agreement from Evoenergy
- ☑ Maintain compliance with the Evoenergy connection agreement
- ☑ Ensure the requirements are met with regard to the design, installation and operation of Low Voltage Embedded Generating systems
- ☑ Meet the connection and commissioning requirements to the LV distribution network

Evoenergy has an obligation to ensure the safe and reliable operation of the distribution system for operating personnel, customers and the general public.

1.4 Statement of Compliance

This document complies with the National DER Connection Guidelines for LV EG Connections, with the exception of the deviations presented in Appendix A: Deviations from the National DER Connection Guidelines.

2. DEFINITIONS AND ABBREVIATIONS

2.1 Definitions

TABLE 1. DEFINITIONS

ACT Government – Electrical Inspectorate	The ACT Government Electrical Inspectorate is the inspecting authority in the ACT and is responsible for inspecting and approving the consumer’s electrical installation <i>Contact number is (02) 6207 7775 Email: electrical.inspections@act.gov.au</i>
Active power limiting	Where the electricity exported from an IES at the AC output terminals of the inverter(s) is limited below a defined threshold
Amp (A)	A unit of electrical current
Anti-islanding protection (Loss of mains)	A protection system to detect islanded conditions and disconnect the IES from the distribution network
Asynchronous generator	Asynchronous generators draw their magnetising current from the distribution network during operation and are generally not capable of isolated operation
Micro embedded generation connection	A connection between a distribution network and a retail customer’s premises for a micro embedded generating unit, for which a model standing offer is in place or an equivalent model offer is in place in jurisdictions not subject to Chapter 5A of the National Electricity Rules

Bi-directional metering	A meter capable of registering energy supplied to the premises and energy exported from the premises as separate data streams
Central protection	Central protection is the protection defined by AS/NZS 4777.1 (grid connection of energy systems via inverters) installed to perform the functions of; coordinating multiple inverter energy system installations at one site, providing protection for the inverter energy system installation and islanding protection to the connected grid as well as preserving safety of grid personnel and the general public
Connection point	The point where the IES is connected to the rest of the electricity network. This is generally at the consumer's main or distribution switchboard
Demand response	The alteration of an inverter's normal mode of operation in response to an initiating signal originating from or defined by a remote agent
Distributed energy resource	Power generation or storage units that are connected directly to the distribution network
DRED (Demand response enabling device)	A device, integral or external to the inverter, which provides the functionalities and capabilities to achieve demand response and meets the requirements of AS/NZS 4755.1
Embedded generating system	A system comprising of multiple embedded generating units. The system rating is defined based off the combined AC output nameplate rating of each generating unit
Embedded generating unit	A generating unit connected within a distribution network and not having direct access to the transmission network
Energy storage system	A system comprising one or more batteries that store electricity generated by distributed energy resources or directly from the grid, and that can discharge the electricity to loads. The Energy Storage System rating is defined based off the AC output nameplate rating of IES connected to the batteries.
Evoenergy	Evoenergy is the ACT's principal Distribution Network Service Provider (DNSP) and is responsible for the distribution of electricity to all customers within the ACT under a regulatory framework. Evoenergy designs, installs, upgrades, repairs and maintains the infrastructure which makes up the distribution network carrying electrical energy to ACT homes and businesses
Export capacity	Combined power that all embedded generator units installed at the consumer's premises are capable of exporting to the network
Export limitation	Where the electricity exported from an IES to the distribution network is controlled so as to not exceed a specified limit. AS/NZS 4777.1 defines two types of export limitation function, namely (i) Hard limit: A limit that will require the IES to disconnect and (ii) Soft limit: A limit that will cause the IES to reduce its output, preventing ongoing export greater than the limit
Export limiting device	Additional hardware installed to perform export limitation This involves monitoring the utility connection point, for clarification regarding export limiting devices please contact Evoenergy on embeddedgeneration@evoenergy.com.au
Generating unit	The plant used in the production of electricity and all related equipment essential to its functioning as a single entity

Generation	The production of electrical power by converting another form of energy in a generating unit
Generator	A person who owns, operates or controls a generating unit
High voltage	Any voltage greater than 1 kV AC
Hybrid inverter	An inverter which can simultaneously manage inputs from both solar panels and a battery bank, charging batteries with either solar panels or the electricity grid
Installed capacity	Combined nameplate rating of all IES installed at the consumer's premises. This may be equal to or greater than the export capacity
Installer	For IES systems, a person who holds an unrestricted electricians licence and CEC accreditation. For non-IES systems; an engineering consultant body or licensed electrical contractor with relevant knowledge, expertise or experience.
Inverter	A device that uses semiconductor devices to transfer power between a DC source(s) or load and an AC source(s) or load
Inverter energy system (IES)	A system comprising one or more inverters together with one or more energy sources (which may include batteries for energy storage) including controls and one or more grid protection devices and where the inverter(s) satisfies the requirements of AS/NZS 4777.2 connected at a single point in an electrical installation
Islanding (Customer islanded mode)	Any situation where the electrical supply from the distribution network is disrupted and one or more IES maintains any form of electrical supply, be it stable or not, to any section of that distribution network
kVA	kilo-Volt Amp, product of voltage and current; a measure of apparent power (combined real and reactive power)
kVAr (Reactive power)	kilo-Volt Amp Reactive; the rate at which reactive energy is transferred. Reactive energy is integral in an alternating current system with inductive or capacitive components. Although it is not useful energy it assists in regulating the local system voltage
kW	kilo-Watt or 1000 Watts; the rate at which active or real (useful) energy is transferred
Low Voltage (LV)	The mains voltages as most commonly used in any given network by domestic and light industrial and commercial consumers (typically 230 V)
Market generating unit	A generating unit whose generation is not purchased in its entirety by a retailer (and receives payment for generation through the National Electricity Market or Wholesale Electricity Market)
Meter Protection Device (MPD)	A fuse or other protection and isolation device located on the unmetered side of the installation, intended for the isolation and protection of the meter and its associated customer installation
Micro embedded generation connection	Means a connection between an embedded generating unit and a distribution network of the kind contemplated by Australian Standard AS 4777 (Grid connection of energy systems via inverters) currently up to 200kVA
Micro IES	Small inverter energy systems (IES) up to 30 kVA of installed capacity (excluding ESS)

Model standing offer	A document approved by the Australian Energy Regulator as a model standing offer to provide micro embedded generation connection services or standard connection services which contains (amongst other things) the safety and technical requirements to be complied with by the proponent. This definition also applies to an equivalent model offer for jurisdictions not subject to Chapter 5A of the National Electricity Rules
Negotiated connection	A connection of an embedded generation unit which is neither a micro EG connection or standard connection for which technical requirements are negotiated between the DNSP and proponent
Network	Evoenergy's distribution network
Point of supply	The junction of the installation's consumer mains with Evoenergy's low voltage distribution network, normally at a connection device (see Evoenergy service and installation rules)
Proponent	A person proposing to become a generator (the relevant owner, operator or controller of the generating unit (or their agent))
Registered generator	A person who owns, operates or controls a generating unit that is connected to, or who otherwise supplies electricity to, a transmission or distribution system and who is registered by the Australian Energy Market Operator as a Generator under Chapter 2 of the National Electricity Rules
Retailer	The holder of a retailer authorisation issued under the National Energy Retail Law in respect of the sale of electricity
Service Protection Device (SPD)	The first protection device located on the network side or forming part of the connection point.
Single phase	Connected between the active of a phase and neutral
Single wire earth return	Parts of the electrical distribution network that use a single live conductor to supply single-phase or split-phase electric power with higher network impedances, and with distribution supplying low voltages to premises
Site generation limit	The generation threshold that the embedded generation system cannot exceed, measured downstream of the connection point
Small generation aggregator	A person who has classified one or more small generating units as a market generating unit
Small registered generator	A generator who elects to register a generator with the Australian Energy Market Operator as a market generating unit who would otherwise be entitled to an exemption to register based on size
Standard connection	A connection service (other than a micro embedded generation connection service) for a particular class (or sub-class) of connection applicant and for which an Australian Energy Regulator approved model standing offer is in place or for which an equivalent model offer is in place in jurisdictions not subject to Chapter 5A of the National Electricity Rules
Supervisory Control and Data Acquisition (SCADA)	A control system that remotely monitors and is capable of switching the embedded generating unit connected to the distribution network

Synchronous Generator	Synchronous generators can operate either in isolation from or connected to the distribution network. When connected to the distribution network, a synchronous generator is “locked into” the distribution network, i.e. operating at the same frequency.
System Capacity	The combined AC output nameplate rating of all embedded generating units installed at the generator’s premises
Three phase	Connected to all phases and neutral (star) or connected between phases (delta)
Utilities Technical Regulation Team	The ACT Government team responsible for the technical administration of utility requirements and administration of the <i>Utilities (Technical Regulation) Act 2014</i>
Volt (V)	Volt; the measure of electrical potential

2.2 Abbreviations



TABLE 2. ABBREVIATIONS

AC	Alternating Current
AEMC	Australian Energy Market Commission
AEMO	Australian Energy Market Operator
AER	Australian Energy Regulator
AS	Australian Standard
AS/NZS	A jointly developed Australian and New Zealand Standard
CBD	Central Business District
CEC	Clean Energy Council
CPEng	Chartered Professional Engineer of Engineers Australia
DC	Direct Current
DER	Distributed Energy Resource
DNSP	Distribution Network Service Provider
EG	Embedded Generation or Embedded Generating
ENA	Energy Networks Australia
ESS	Energy Storage System
FAT	Factory Acceptance Testing
GDL	Generation Dispatch Limiter
HV	High Voltage
IEC	International Electrotechnical Commission

IES	Inverter Energy System
LV	Low Voltage
MW	Megawatt
NBN	National Broadband Network
NEM	National Electricity Market
NER	National Electricity Rules
NMI	National Metering Identifier
PV	Photovoltaic
ROCOF	Rate of Change of Frequency
RPEng	Registered Professional Engineer of Professionals Australia
RPEQ	Registered Professional Engineer of Queensland
SCADA	Supervisory Control and Data Acquisition
SCR	Short Circuit Ratio
SWER	Single Wire Earth Return
UTR	Utilities Technical Regulation Team
xDSL	X Digital Subscriber Line

2.3 Terminology

To assist with the interpretation and application of the requirements specified in this document, the following instructional terms have been used:

-  The word 'shall' indicates a mandatory requirement
-  The word 'may' indicates a requirement that may be mandatorily imposed on the proponent
-  The word 'should' indicates a recommendation that will not be mandatorily imposed on the proponent

2.3.1 Subcategories

To assist proponents in identifying technical requirements that are applicable to a specific system, Evoenergy have defined several sub-categories. The definitions for each subcategory are outlined in Table 3.

TABLE 3. SUBCATEGORY DEFINITIONS

LV EG IES (≤ 200kVA)	Exporting	Any LV EG system, that is not a micro EG system, with a total system capacity less than or equal to 200 kVA for a three-phase IES (excluding ESS) network connection, meeting all relevant technical requirements for LV EG connections set out in the Evoenergy technical requirements document. These systems are further subcategorised as exporting or non-exporting
	Non-Exporting	
LV EG IES (> 200kVA)	Exporting	Any LV EG system, with a total system capacity greater than 200 kVA and less than or equal to 1.5 MVA for a three-phase IES (excluding ESS) network connection, meeting all relevant technical requirements for LV EG connections set out in the Evoenergy technical requirements document. These systems are further subcategorised as exporting or non-exporting
	Non-Exporting	
LV EG Non- IES	Exporting	LV EG non-IES connection – Any LV EG system, that is synchronous or asynchronous, with a total system capacity greater than 0 kVA and less than or equal to 50 kVA for a single phase network connection or 1.5 MVA for a three-phase network connection, meeting all relevant technical requirements for LV EG connections set out in the Evoenergy technical requirements document. These systems are further subcategorised as exporting or non-exporting
	Non-Exporting	

The maximum LV system capacity of 1.5 MVA is the indicative limit for proponents being required to implement a HV connection. Proponents applying to connect near or above this capacity should contact Evoenergy to determine if an LV connection is appropriate.

Exporting systems shall be considered as LV EG systems operating in parallel with the distribution network and capable of exporting electricity via partial or full export into the network, where:

- ☛ Partial-export LV EG systems limit the amount of export into the LV distribution network to an agreed export threshold defined in the connection agreement
- ☛ Full-export LV EG systems can export into the LV distribution network to the full nameplate capacity (full AC rating) as defined in the connection agreement

Non-exporting systems shall be considered as LV EG systems operating in parallel with the LV distribution network that are limited to ensure they cannot export electricity into the LV distribution network as defined in the connection agreement.

Evoenergy can be contacted via the contact details on the Evoenergy [website](#) for any clarification regarding the definitions and application of subcategories.

3. RELEVANT RULES, REGULATIONS, STANDARDS AND CODES

3.1 Evoenergy Documents

Table 4 lists the relevant Evoenergy documents that shall be considered in the application of the LV EG technical requirements.

TABLE 4. RELATED EVOENERGY DOCUMENTATION

Evoenergy Service and Installation Rules	Sets out the requirements and associated obligations and procedures for the safe, reliable and efficient connection of electrical installations to an electricity network
Evoenergy Connection Policy	Sets out the circumstances in which connection charges are payable and the basis for determining the amount of such charges. The policy has been prepared in accordance with the requirements in Chapter 5A of the National Electricity Rules (Rules) and the Australian Energy Regulator's (AER's) Connection charge guidelines for retail electricity customers, under Chapter 5A of the National Electricity Rules, version 1.0 (AER connection charge guidelines)

3.2 Standards and Codes

There are a number of Australian and International Standards which specify technical requirements for network connections of generating units and performance requirements. These are outlined in Table 5.

TABLE 5. RELATED AUSTRALIAN AND INTERNATIONAL STANDARDS

STANDARD NUMBER	STANDARD NAME	STANDARD TYPE
AS 3011	Secondary batteries installed in buildings	Australian Standard
AS 4086	Secondary batteries for use with stand-alone systems	Australian Standard
AS 60034.1	Rotating electrical machines, Part 1: Rating and performance	Australian Standard
AS 60034.22	Rotating electrical machines, Part 22: AC generators for reciprocating internal combustion (RIC) engine driven generating sets	Australian Standard
AS 60038	Standard voltages	Australian Standard
AS 60044	Instrument transformers (multiple parts)	Australian Standard
AS/NZS 3000	Electrical installations (known as the Australian/ New Zealand Wiring Rules)	Australian/ New Zealand Joint Standard
AS/NZS 3008.1.1	Electrical installations - Selection of cables. Part 1.1: Cables for altering voltages up to and including 0.6/1 kV – Typical Australian installation conditions	Australian/ New Zealand Joint Standard

AS/NZS 4755.1	Demand response capabilities and supporting technologies for electrical products –Part 1: Demand response framework and requirements for demand response enabling devices (DREDS)	Australian/ New Zealand Joint Standard
AS/NZS 4777	Grid connection of energy systems via inverters (multiple parts)	Australian/ New Zealand Joint Standard
AS/NZS 5033	Installation and safety requirements for photovoltaic (PV) arrays	Australian/ New Zealand Joint Standard
AS/NZS 61000.4.3	Electromagnetic compatibility testing and measurement techniques – Power quality measurement methods	Australian/ New Zealand Joint Standard
AS/NZS IEC 60947.6-1	Low-voltage switchgear and control gear - Multiple function equipment - Automatic transfer switching equipment	Australian/ New Zealand Joint Standard
IEC 60255-12	Electrical relays - Part 12: Directional relays and power relays with two input energizing quantities	International Standard
IEC 60255-127	Measuring relays and protection equipment - Part 127: Functional requirements for over / under voltage protection	International Standard
IEC 60255-26	Electrical relays - Part 26: Electromagnetic compatibility requirements	International Standard
IEC 60255-27	Electrical relays - Part 27: Product safety requirements	International Standard
IEC 62109	Safety of power converters for use in photovoltaic power systems	International Standard
IEC 62116	Utility-interconnected photovoltaic inverters – Test procedure of islanding prevention measures	International Standard
IEC 62786	Distributed energy resources connection with the grid	International Standard
IEEE standard 1547-2018	IEEE Standard for Interconnecting Distributed Resources with Electric Power Systems	International Standard
SA/SNZ TR IEC 61000.3.14	Electromagnetic compatibility (EMC), Part 3.14: Limits – Assessment of emission limits for harmonics, interharmonics, voltage fluctuations and unbalance for the connection of disturbing installations to LV power systems	AU/NZ Technical Report

SA/SNZ TR IEC 61000.3.15	Electromagnetic compatibility (EMC), Part 3.15: Limits – Assessment of low frequency electromagnetic immunity and emission requirements for dispersed generation systems in LV network	AU/NZ Technical Report
-------------------------------------	--	------------------------

In the event of an inconsistency between the Evoenergy technical requirements, Australian standards, international standards and industry codes, the Evoenergy technical requirements shall prevail.

3.3 Legislation and Regulation

This section provides a list of the relevant legislation and regulations which shall apply to the design, manufacture, installation, testing, commissioning, operations and maintenance of all plant and equipment for LV EG connections to the Evoenergy distribution network.

-  Electrical Safety Act 1971
-  Electrical Safety Regulation 2004
-  Utilities Act 2000
-  Utility Networks (Public Safety) Regulations 2001
-  Utilities (Technical Regulation) Act 2014
-  Electricity Feed-in (Renewable Energy Premium) Act 2008
-  Electricity Service and Installation Rules Code Determination 2013
-  Electricity Network Boundary Code Determination 2013
-  Electricity Distribution Supply Standards Code Determination 2013
-  Work Health and Safety Act
-  Work Health and Safety Regulation
-  National Electricity Rules (Chapter 5)

In an event where there is any inconsistency between legislation and regulations and these technical requirements, the legislation and regulations shall prevail.

4. TECHNICAL REQUIREMENTS

This section specifies the detailed technical requirements for LV Embedded Generators. The technical requirements specified in this section should be interpreted as applying to all subcategories of LV EG connections unless otherwise specified. The relationship between the sub-categories and the associated technical settings is displayed in Figure 2.

FIGURE 2. SUBCATEGORY HIERARCHY

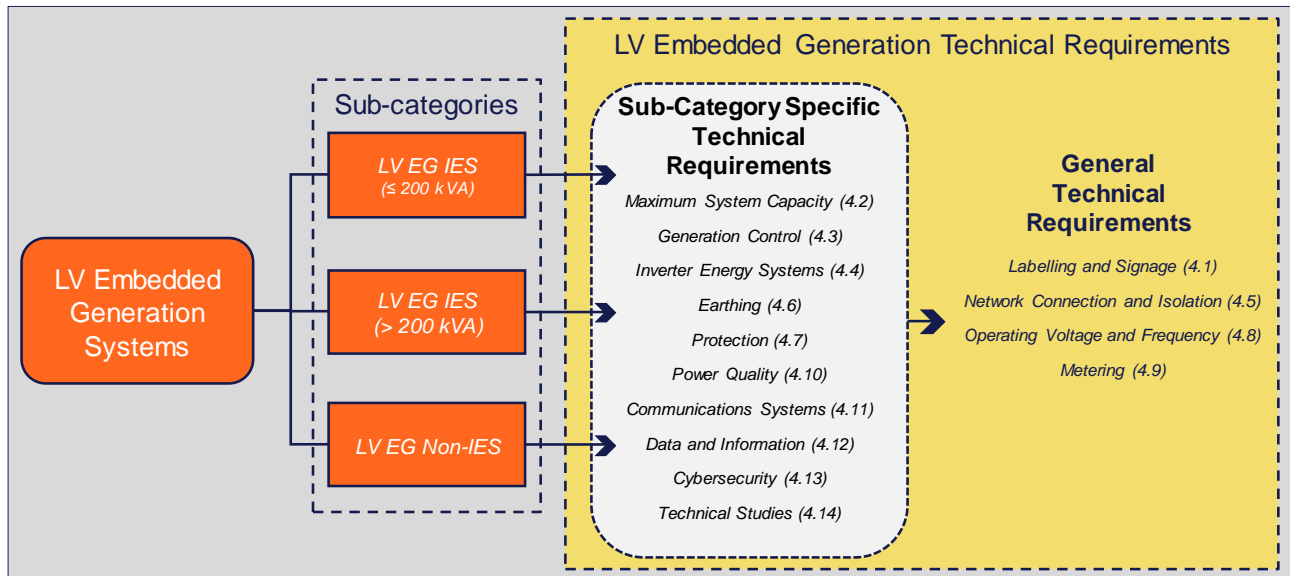

4.1 Labelling and Signage

The labels and signs on the installation, including cables, shall be as per the labelling requirements specified in AS/NZS 4777.1, AS/NZS 3000 and AS/NZS 5033. In the event the installation requires an external isolation switch to enable network isolation (as outlined in Section 4.5) the isolation switch shall be labelled as per the requirements specified in AS/NZS 4777.1

4.2 Maximum System Capacity

This section specifies the maximum system capacity of the LV EG connections for each sub-category. These values are inclusive of all generating sources including ESS.





TABLE 6. MAXIMUM SYSTEM CAPACITY FOR EACH SUBCATEGORY

SUBCATEGORY	MAXIMUM SYSTEM CAPACITY (INCLUDING ESS)
LV EG IES (≤ 200kVA)	LV EG IES (including ESS) connection ≤200 kVA – For LV EG connections of IES (including ESS), the maximum system capacity at the same connection point shall be set to less than or equal to 200 kVA
LV EG IES (> 200kVA)	LV EG IES (including ESS) connection >200 kVA – For LV EG connections of IES (including ESS), the maximum system capacity at the same connection point shall be determined at the time of application but shall typically be greater than 200 kVA and less than or equal to 1.5 MVA
LV EG Non-IES	LV EG non-IES connection – For LV EG connections of non-IES, the maximum system capacity shall be determined at the time of application but shall typically be greater than 0 kVA and less than or equal to 50 kVA for single phase or less than or equal to 1.5 MVA for three phase

4.3 Generation Control

4.3.1 Export Limits at Connection Point

Export limitation may be required for particular LV EG connections, this will be determined by Evoenergy upon performing a network technical study. The factors that will be considered in determining an export limit include, but are not limited to;

-  Existing Asset Ratings
-  Power Quality at the relevant network location
-  Existing and forecast DER penetration at the relevant network location
-  Existing demand at peak generation

Export limitation shall be achieved through the use of a dedicated export limiting device; details of the configuration shall be provided on the single line diagram submitted to Evoenergy. The export limiting functionality shall be of the “soft” limitation type as defined in AS/NZS 4777.1.

Where export limitation settings can be changed via a keypad or switches, adequate security must be employed to prevent any tampering / inadvertent / unauthorised changes. Suitable locks or a password system shall be used.

The export limit is a maximum limit and the ability to export at the defined limit is not guaranteed as it is dependent upon network characteristics which change over time. Several factors can result in the need for the limit to be constrained, for example, the operation of active power quality response modes.

4.3.2 Site Generation Limit Downstream of Connection Point

Evoenergy site generation limits are as defined for each subcategory in Section 4.2 – Maximum System Capacity.

4.4 Inverter Energy System

For inverter energy systems, the IES shall comply with the following technical requirements:

-  shall be tested by an authorised testing laboratory and be certified as being compliant with AS/NZS 4777.2 with an accreditation number

- ☑ shall comprise of inverters that are registered with CEC as approved grid connect inverters
- ☑ shall comprise of inverters that are tested by an authorised testing laboratory and certified as being compliant with IEC 62116 for active ant islanding protection as per AS/NZS4777.2
- ☑ shall comprise of inverters installed in compliance with AS/NZS 4777.1
- ☑ shall comprise of inverters that have both volt-var and volt-watt response modes available.

4.5 Network Connection and Isolation

There shall be a visible method of ensuring the LV EG system is disconnected from the distribution network for all residential and commercial systems. The method of isolation shall be safely accessible to Evoenergy personnel at all times. The location shall not be located behind fences and shall always be kept clear. If access is obstructed, the embedded generator shall remove the obstruction or relocate the method of isolation. Switches designated as main switches for inverter supply shall be as per AS/NZS 4777.1. As a minimum, mechanical isolation shall be as per AS/NZS 3000 and lockable in the open position.

Where an ESS and IES are physically integrated, the isolation switches and isolation arrangements shall also comply with AS/NZS 5033.

Any additional requirements for network connection and isolation for Non-IES connections will be determined by Evoenergy and communicated to the proponent in the connection application stage.

If the requirement for access as specified in this section cannot be achieved, special approval for the connection of the IES shall be sought from Evoenergy via the contact details on the Evoenergy [website](#).

4.5.1 Shared Generation

Shared generation is where an embedded generation unit/s, or system, is electrically connected to, supplying, and shared between, multiple generators.

Evoenergy recommends that proponents utilising a shared generation arrangement engage an Embedded Network Manager to become an embedded network. In such an instance, the network connection point moves from the generator (now child) connection point to a new agreed parent connection point.

4.6 Earthing

The LV EG system earthing shall be in compliance with the Evoenergy Service and Installation Rules in addition to the requirements specified in Table 7.

TABLE 7. EARTHING REQUIREMENTS

SUBCATEGORY	EARTHING REQUIREMENTS
LV EG IES (≤ 200kVA)	Earthing requirements shall be as per AS/NZS 3000 and AS/NZS 4777.1
LV EG IES (> 200kVA)	Earthing requirements shall be as per AS/NZS 3000 and AS/NZS 4777.1
LV EG Non-IES	Earthing requirements shall be as per AS/NZS 3000 and AS/NZS 3010

All systems with ESS shall adhere to the earthing requirements specified in AS 3011.

4.7 Protection

This section specifies the protection requirements for the subcategories of LV embedded generators connected to the Evoenergy network. Protection systems for LV embedded generators shall be designed in accordance with the relevant Acts, Regulations and Evoenergy requirements.

4.7.1 Inverter Integrated Protection

For LV EG IES systems, inverter integrated protection shall be as per AS/NZS 4777.1 and AS/NZS 4777.2. The passive anti-islanding protection set points and limits for sustained operation are defined in Table 8.

TABLE 8. INVERTER PROTECTION SET-POINT VALUES (AS/NZS 4777.2)

PROTECTIVE FUNCTION	PROTECTIVE FUNCTION LIMIT	TRIP DELAY TIME	MAXIMUM DISCONNECTION TIME
Undervoltage (V<)	180 V	1 s	2 s
Overvoltage (V>)	260 V	1 s	2 s
Overvoltage (V>>)	265 V	-	0.2 s
Under-frequency (F<)	47 Hz	1 s	2 s
Over-frequency (F>)	52 Hz	-	0.2 s
Sustained Overvoltage (V _{nom_max} 10-minute average)	258 V	-	3 s
Increase in frequency (f _{stop})	52 Hz	<i>Inverter response as outlined in AS/NZS 4777.2 Section 7.5.3.1</i>	
Decrease in frequency (only applicable to inverters with Energy storage)	49.75 Hz	<i>Inverter response as outlined in AS/NZS 4777.2 Section 7.5.3.2</i>	

Active anti-islanding protection shall be implemented as per AS/NZS 4777.2 and shall operate the automatic disconnection device within two (2) seconds of disruption to the power supply from the grid.

4.7.2 Central Protection

Central protection is required for all subcategories of LV embedded generators connected to the Evoenergy network. Central protection shall be implemented in the form of a protection relay that complies with the relevant Australian and International Standards, for more information regarding the suitability of protection relays please contact Evoenergy via the details listed on the [website](#).

The application of central protection parameters for each sub category is specified in Table 9. The detailed protection parameters as are specified in the following subsections.

TABLE 9. CENTRAL PROTECTION REQUIREMENTS BY SUBCATEGORY

PROTECTIVE FUNCTION	LV EG IES				LV EG Non-IES	
	≤ 200 KVA		> 200 KVA		Exporting	Non-Exporting
	Exporting	Non-Exporting	Exporting	Non-Exporting		
Grid reverse power (32R)	✘	✓	✘	✓	✘	✓
Generator circuit Phase balance protection (46/47)	*	*	*	*	✓	✓
Overcurrent facility fault, grid fault and earth fault protection (50/51)	✓	✓	✓	✓	✓	✓
Passive anti-islanding protection (27, 59, 81U/O, 81R)	✓	✓	✓	✓	✓	✓
Inter-tripping	✘	✘	*	*	*	*
Power Factor Control	✓	✓	✓	✓	✓	✓

The symbols used to denote the above requirements have the following meanings:

- ✓ Shall be required
- * May be required
- ✘ Shall not be required

4.7.2.1 Grid Reverse Power Protection

Grid reverse power protection shall be implemented on all non-exporting systems. The parameters for reverse power are specified in Table 10.

TABLE 10. GRID REVERSE POWER PROTECTION REQUIREMENTS

PROTECTION ELEMENT	SETTING LIMIT	DISCONNECTION TIME
Grid Reverse Power (32R)	5% of EG Rating	2 seconds

Grid reverse power flow shall be set as low as practicable with the consideration of the protection relay, CT accuracy and generating system characteristics. The design of control systems shall minimise reverse power flow immediately following synchronisation.

4.7.2.2 Phase Balance Protection

LV EG connections shall have phase balance protection that consists of both current and voltage unbalance elements as outlined in the following subsections.

Three-phase IES with inverter-integrated phase balance protection are exempt from this requirement.

4.7.2.2.1 Current Unbalance Protection

Current unbalance requirements shall be implemented in central protection as specified in Table 11.

TABLE 11. CURRENT UNBALANCE PROTECTION REQUIREMENTS

PROTECTION ELEMENT	SETTING THRESHOLD	ELEMENT DELAY
Current Unbalance (46)	Greater than 10% of Full Load Current	5 seconds

Current unbalance protection does not apply to single phase connected non-IES. However, Evoenergy may determine from a connection specific technical study that a three-phase embedded generator shall be utilised.

4.7.2.2.2 Voltage Unbalance Protection

Voltage unbalance requirements shall be implemented in central protection as specified in Table 12.

TABLE 12. VOLTAGE UNBALANCE PROTECTION REQUIREMENTS

PROTECTION ELEMENT	NEGATIVE SEQUENCE LIMIT	ELEMENT DELAY
Voltage Unbalance (47)	10% of Nominal Voltage	5 seconds

4.7.2.3 Overcurrent Facility Fault, Overcurrent Grid Fault and Earth Fault Protection

Bi-directional overcurrent and earth fault protection shall be enabled in central protection. This protection shall be set to detect faults within the proponent's installation and the Evoenergy network, these settings shall be determined by the proponent during the system design phase and shall grade with existing protection systems.

4.7.2.4 Passive Anti-islanding Protection

Passive anti-islanding protection shall be implemented for all IES systems as per Table 13.

TABLE 13. CENTRAL VOLTAGE AND FREQUENCY PROTECTION SET POINTS FOR IES SYSTEMS

SETTING PARAMETER	DISCONNECTION TIME	SETTING LIMIT
Stage 1 Over voltage (V>)	2 seconds	258 V (10-minute average)
Stage 2 Over voltage (V>>)	2 seconds	260 V
Stage 1 Under voltage (V<)	2 seconds	216 V (10-minute average)
Stage 2 Under voltage (V<<)	2 seconds	204 V
Over frequency (F>)	2 seconds	52 Hz
Under frequency (F<)	2 seconds	47 Hz
Rate of Change of Frequency (ROCOF)	2 second time delay	1.0 Hz / 1 second

Passive anti-islanding protection shall be implemented for all Non-IES systems, the settings shall be determined by the proponent on a case-by-case basis and provided to Evoenergy for approval.

4.7.2.4.1 Customer Islanded Mode

Generators can seek approval from Evoenergy to operate in customer islanded mode. In addition to Evoenergy approval, the following operational conditions must also be satisfied:

- 📌 Embedded generating unit is electrically disconnected from the distribution network, either manually or as the result of automatic disconnection from a loss of supply, prior to becoming a customer island
- 📌 Reconnection of the customer island to the distribution network must not occur until the network supply has been fully restored and stabilised such that synchronisation from within the generator's installation can occur
- 📌 The islanded embedded generating unit must only supply the generator's installation, or a section of the generator's installation, which have also been electrically disconnected from the distribution network

4.7.2.5 Inter-tripping

The requirement for implementing inter-trip protection for Non-IES systems will be determined on a case-by-case basis through a network technical study. The indicative threshold where Evoenergy will consider mandating an inter-trip scheme is 200 kVA, if a proponent is installing a system at or near this threshold it is recommended that they contact Evoenergy via the details on the Evoenergy [website](#).

In the event an inter-tripping scheme is required, Evoenergy will work with the proponent to establish the following:

- 📌 Design parameters for the communication interface
- 📌 The responsibilities and for implementation and monitoring of the communication link
- 📌 The philosophy of the inter-trip scheme including the process when the communication link fails or supply to the protection scheme is lost

Evoenergy may grant written approval for the proponent to install Neutral Voltage Displacement (NVD) protection utilising a voltage transformer on Evoenergy's HV distribution network. LV EG connections with NVD protection will not be required to install inter-trip protection.

For LV EG Non-IES non-exporting connections, inter-tripping may not be required provided minimum import protection is installed. Where an inter-trip scheme has been implemented, reverse power protection may not be required.

More information regarding the requirements and fees associated with the configuration of inter-trip and NVD protection can be obtained by contacting Evoenergy via the details provided on the Evoenergy [website](#).

4.7.3 Interlocking

IES systems with single phase inverters installed in a three phase arrangement shall be interlocked and configured to behave as an integrated multiphase inverter providing balanced output (maximum unbalance between phases of 5 kVA) to all connected phases.

Three phase inverters shall have integrated phase balance protection as per AS/NZS 4777.2. Where this function is not integral to the inverter a separate central protection system shall be implemented as per Section 4.7.2.2.

4.7.4 Power Factor Control

LV EG connections shall maintain the power factor at the point of connection within the limits specified by the Evoenergy Service and Installation rules. All systems shall have Power Factor protection or Reactive Power Control enabled.

The power factor protection settings for IES systems are specified in Table 14.

TABLE 14. POWER FACTOR PROTECTION SETTINGS

SETTING PARAMETER	SETTING LIMIT	DISCONNECTION TIME
Power Factor	0.95 Leading	5 Seconds
	0.90 Lagging	5 Seconds

The reactive power protection settings for IES systems are specified in Table 15.

TABLE 15. REACTIVE POWER PROTECTION SETTINGS

SETTING PARAMETER	SETTING LIMIT	DISCONNECTION TIME
Reverse VAr	0.33 x P _{RATED}	5 Seconds
Over VAr	0.48 x P _{RATED}	5 Seconds

Power Factor Control shall be implemented for all Non-IES systems, the settings shall be determined by the proponent on a case-by-case basis and provided to Evoenergy for approval.

For systems where power quality response modes are enabled, entering into a power quality response mode may cause unintended tripping of central protection. Therefore, for systems where power quality response modes are enabled, power factor and reactive power protection set points may be reduced to a point where unintended tripping will not occur. However, protection shall not be disabled. Please see Section 4.10 – Power Quality for response mode settings.

4.7.5 Synchronisation

Automatic synchronising and synchronisation check closing protection shall be installed at all locations where it is intended that parallel operation of a generating unit will occur, to prevent non-synchronised connection to the distribution network.

Connection of the generating unit in parallel with the distribution network shall be prevented unless all phases of the distribution network at the network connection point are energised.

4.7.6 Additional Requirements for LV EG Non-IES

There are no additional protection requirements for LV EG Non-IES connections to those specified above.

4.8 Operating Voltage and Frequency

The system shall be designed and installed to limit voltage rise to 2% from the point of supply to the LV EG terminals. Regardless of the connection method applied, the voltage rise for an embedded generation system shall be calculated based on the maximum current imbalance permitted by the system in accordance with AS/NZS 4777.1 Appendix C3.

The operating voltage and frequency shall be within the limits specified in Section 4.7.

4.9 Metering

LV EG connections shall not be energised without the correct metering arrangement in place. The proponent shall contact the retailer to ensure metering requirements for grid connected IES installations are fulfilled prior to energising the system.

4.10 Power Quality

4.10.1 Quality of Supply & Generation

The National Electricity Rules place certain responsibilities on Evoenergy for maintaining the quality of supply within the network. Evoenergy are responsible for adhering to relevant jurisdictional based regulations and licence conditions regarding power quality parameters including:

- 📁 Network Voltage Control
- 📁 Voltage Fluctuations and Step Voltage
- 📁 Harmonics
- 📁 Voltage Balance

The LV EG connection shall not adversely impact Evoenergy's ability to meet these requirements and shall comply with the applicable power quality requirements as well as relevant state-based regulations and licence conditions.

4.10.2 LV EG IES Power Quality Response Modes

All LV EG IES systems shall have volt-watt power quality response enabled as per AS/NZS 4777.2 Clause 6.3.2.2 with the settings detailed in Table 16.

TABLE 16. VOLT-WATT RESPONSE

AS/NZS 4777.2 REFERENCE	VOLTAGE	POWER LEVEL (% RATED POWER)
V1	207 V	100%
V2	220 V	100%
V3	250 V	100%
V4	258 V	20%

In addition, LV EG IES shall have volt-var power quality response enabled as per AS/NZS 4777.2 Clause 6.3.2.3 with the settings detailed in Table 17.

TABLE 17. VOLT-VAR RESPONSE

AS/NZS 4777.2 REFERENCE	VOLTAGE	VAR LEVEL (% OF RATED VA)
V1	207 V	30% Leading
V2	220 V	0%
V3	250 V	0%
V4	258 V	30% Lagging

The ramping requirements for IES power quality response modes shall be the default values specified in AS/NZS 4777.2.

In some cases, Evoenergy may request alternate settings be enabled, including application of fixed power factor, for specific installations and will communicate these to proponents upon receiving a connection application.

Proponents shall ensure that power quality settings are uniform across systems with multiple inverters. The replacement of inverters, including warranty replacements, shall be configured to have power quality response modes enabled. IES power quality response modes and settings shall not be altered without written approval from Evoenergy.

4.10.3 LV EG Non-IES Power Quality Response

LV EG Non-IES connections shall be designed and operated to adequately control real and reactive power output through either Voltage control mode or fixed power mode.

The power quality response mode and associated settings for LV EG Non-IES connection shall be determined through a network technical study.

4.11 Communication Systems

4.11.1 LV EG IES less than or equal to 200 kVA (Excluding ESS) Communications Systems

Evoenergy do not currently mandate communication requirements for LV EG IES less than or equal to 200kVA. However, Evoenergy do engage in demand management programs that are implemented through third party aggregators. More information regarding these programs can be found on the Evoenergy [website](#).

4.11.2 LV EG IES greater than 200 kVA (Excluding ESS) Communications Systems

Exporting LV EG IES connections greater than 200 kVA shall adhere to the following communication requirements. Evoenergy do not mandate communication requirements for non-exporting LV EG IES systems.

4.11.2.1 SCADA Architecture Requirements

Evoenergy’s general SCADA architecture and interface for embedded generation systems is given below:

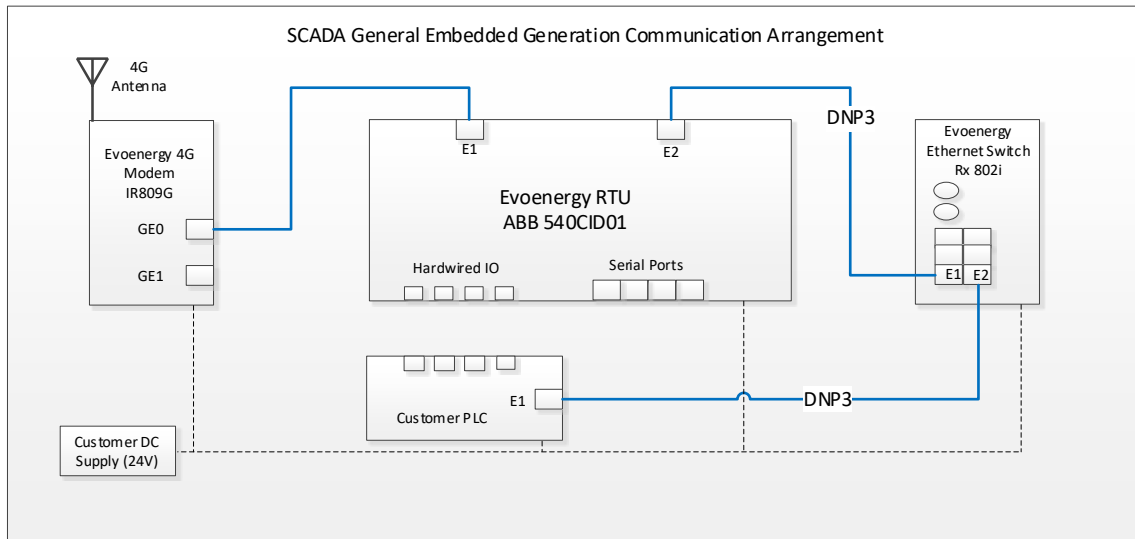

This arrangement may vary on a project-specific basis as determined by Evoenergy upon receipt of the application for connection. Direct fibre optic connection into Evoenergy’s SCADA network may be required in the place of the 4G modem for some installations (mandatory where inter-tripping schemes are required). Where the proponent’s installation includes both a PLC and other devices, the PLC only shall be used to interface directly with Evoenergy’s RTU. Any IO required from the protection relay or any other devices (e.g. metering equipment) shall be provided to Evoenergy through the PLC.

The proponent’s installation shall contain provision for the installation and DC supply of Evoenergy communication equipment including, but not limited to; a remote terminal unit (RTU), a switch, a modem and an external 4G antenna. Evoenergy will procure these assets and issue these to the proponent for installation within their system. The DC system is required to support a combined power consumption of 40W for these assets as minimum.

Fibre optic cable is the preferred method for all communications between Evoenergy’s RTU and the proponent’s PLC. Copper Ethernet cabling may be accepted for short connections not greater than 10m within the same or an adjacent enclosure.

All Evoenergy owned communication equipment located within the EG system shall be protected from vermin and weather and must not exceed normal operating temperature range. Evoenergy shall have unrestricted access to the equipment at all times.

4.11.2.2 SCADA Protocol Requirements

DNP3 or Modbus over TCP/IP are the required protocols for all communications between Evoenergy’s RTU and the proponent’s PLC. The requirements for each of these protocols is provided below. Note: digital inputs and outputs may also be accepted as hard-wired voltage-free contacts on a project specific basis.

4.11.2.2.1 DNP3 Requirements

For DNP3 interfaces the following groups and variations will be used:

- Digital Output Controls: Group 12 Variation 1 (Direct Operate).
- Digital Inputs: Group 1 Variation 2, Object 2 Variation 2.
- Analog Inputs: Object 30 Variation 2, Object 32 Variation 2.

The generator system is also required to support polling by classes and DNP3 time synchronisation. Evoenergy’s RTU will poll the proponent’s PLC for data once every 2 seconds.

4.11.2.2.2 Modbus Requirements

For Modbus interfaces the following tables will be used:

- Digital Output Controls: Coils.
- Digital Inputs: Discrete Inputs.

- Analog Inputs: Input Registers, 16-bit signed values

Evoenergy’s RTU will poll the proponent’s PLC for data once every 2 seconds.

4.11.2.3 SCADA IO Requirements

The following SCADA IO are required (Inputs/Outputs are from the perspective of Evoenergy’s RTU).

4.11.2.3.1 Digital Outputs

I/O	DESCRIPTION
Generator CB Trip	<p>This output allows Evoenergy to trip the proponent’s generator CB and disconnect the generation from Evoenergy’s network during emergency situations.</p> <p>Only trip is required (close not required).</p>
Generator CB Close Enable/Disable	<p>This signal provides Evoenergy with the ability to prevent the generation from connecting to Evoenergy’s network during fault or emergency conditions.</p> <p>If the ‘Generator CB Close Disable’ is sent, the proponent is not permitted to close the generator CB and connect their generation to Evoenergy’s network. The proponent needs to implement appropriate logic and interlocking within their system to ensure that the generator CB cannot be closed when the “Generator CB Close Disable” has been sent.</p> <p>To connect the generation to Evoenergy’s Network, the proponent must contact Evoenergy’s control room to request permission. The ‘Generator CB Close Enable’ signal will be sent once Evoenergy is satisfied that it is safe for the generation to be connected.</p> <p>Logic will be implemented within Evoenergy’s RTU to automatically send the ‘Generator CB Close Disable’ signal to the proponent’s PLC under the following conditions:</p> <ul style="list-style-type: none"> • ‘Generator CB Trip’ Control is sent by the Evoenergy RTU. • A ‘Protection Operated’ signal is received from the PLC by Evoenergy’s RTU. <p>Note: If the CB is currently closed and the ‘Generator CB Close Disable’ control is sent by Evoenergy’s RTU, this does not require the CB to trip. The generator may remain connected and continue to generate on receipt of this signal.</p>
Communications Heartbeat	<p>The proponent is responsible for monitoring the integrity of the communications link between Evoenergy’s RTU and the proponent’s PLC. Evoenergy will provide a ‘Communications Heartbeat’ signal for this purpose. This signal will provide regular pulses at one-minute intervals with 5 consecutive missed pulses over a 5-minute period indicating a loss of communications. The required action for the generation system following a loss of communications will be one of the following (dependent on the particular installation):</p> <ul style="list-style-type: none"> • Allow the generation to continue operating (if currently running) but prevent the generation from re-connecting if not already connected. • Limit the generation export to a predefined set value. • Initiate an automatic controlled shut down of the generating system.

Additional Digital Outputs may be required on a project specific basis.

4.11.2.3.2 Digital Inputs

I/O	DESCRIPTION
Protection Operated	This signal indicates whether the proponent's generation protection relay has operated and tripped the generator circuit breaker.
CB Close Enabled	This signal indicates whether proponent close control is currently inhibited. This is a back indication from Evoenergy's 'Generator CB Close Enable/Disable Close' Control.
CB Closed	Generator circuit breaker closed status indication. Where additional circuit breakers exist between the generation source and the connection point to Evoenergy's network the 'CB closed' status will also be required for these additional circuit breakers.
DC Supply Fail	Fail indication for the proponent's DC system.
PLC Fail	Fail indication from proponent's PLC or protection relay.

Additional Digital Inputs may be required on a project specific basis.

4.11.2.3.3 Analog Inputs

I/O	DESCRIPTION
Per Phase Current	Measured at the Evoenergy network connection point.
Per Phase Voltage	Measured at the Evoenergy network connection point.
Three Phase Active Power	Measured at both the Evoenergy network connection point and the generation source.
Three Phase Reactive Power	Measured at both the Evoenergy network connection point and the generation source.
Three Phase Power Factor	Measured at both the Evoenergy network connection point and the generation source.

Additional Analog Inputs may be required on a project specific basis

4.11.2.3.4 SCADA Single Line Diagram

The following simplified single line diagram summarises Evoenergy' embedded generation SCADA IO requirements.

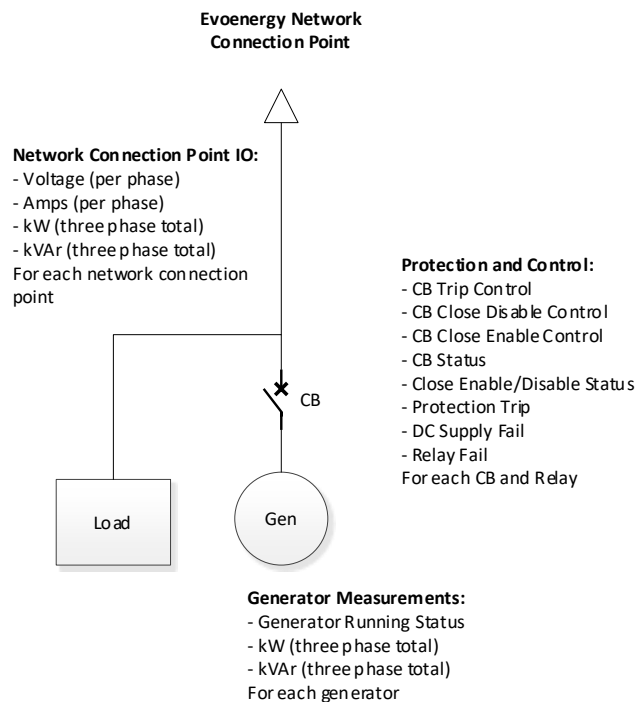

4.11.2.3.5 SCADA Design Requirements

The following details are required as part of the proponent's SCADA design submission:

- 📁 Overall communications architecture including details of the physical and protocol level interfaces to Evoenergy's SCADA equipment.
- 📁 Generator control system panel/cubicle layout including proposed location for Evoenergy's SCADA equipment.
- 📁 Generator system single line diagram and proposed connection point to Evoenergy's network.
- 📁 Details on the proposed PLC used to interface with Evoenergy's SCADA equipment.
- 📁 SCADA IO schedule with nominated addresses for each IO point (Evoenergy will nominate Server/Client Protocol and IP addresses for the Evoenergy's RTU and the proponent's PLC).

4.11.2.4 Inter-tripping Interface

Where an inter-tripping interface is required, Evoenergy will provide the required inter-tripping signals using SEL mirrored bits over fibre optic cable. These signals will be determined on a project specific basis.

4.11.3 LV EG Non-IES Communication Systems

Exporting LV EG Non-IES connections shall adhere to the same requirements for IES systems stated above in 4.11.2.

4.12 Data and Information

4.12.1 Static Data and Information





The static data and information required to be provided by the proponent to Evoenergy is specified in *Appendix D: Static Data and Information*.

4.12.2 Dynamic Data and Information

Dynamic Data requirements are specified in 4.11 above.

4.13 Cyber Security

All systems with communications requirements as outlined in Section 4.11 shall adhere to the following cyber security requirements:

-  All monitoring and communications devices shall be in lockable enclosures accessible to Evoenergy and designated personnel
-  All devices and settings shall have password protection implemented
-  Access to the generating unit shall be restricted for required monitoring only
-  Evoenergy's SCADA communications network must be physically isolated from proponent's business networks and external networks

Evoenergy can provide additional information to proponents regarding cyber security requirements for specific systems via the contact details on the Evoenergy [website](#).

4.14 Technical Studies

Technical studies for LV EG connections shall be performed as outlined in Table 18.

TABLE 18. TECHNICAL STUDY REQUIREMENTS FOR LV EG CONNECTIONS

TECHNICAL STUDIES	LV EG IES				LV EG Non-IES	
	≤ 200 KVA		> 200 KVA		Exporting	Non-Exporting
	Exporting	Non-Exporting	Exporting	Non-Exporting		
Voltage Level (including power factor)	*	*	✓	*	✓	✓
Load Flow	*	*	✓	*	✓	✓
Fault Level	*	*	✓	*	✓	✓
Protection Grading including islanding risk evaluation	*	*	✓	*	✓	✓

The symbols used to denote the above requirements have the following meanings:

- ✓ Shall be required
- * May be required
- ✗ Shall not be required

Evoenergy shall undertake technical studies for all systems with a capacity of less than or equal to 1.5 MVA. Systems above this capacity will require the proponent to engage a suitably qualified engineer to perform the study for Evoenergy review prior to installation. Evoenergy will contact the proponent and specify the DNSP inputs, scope of the study and criteria for assessment upon receiving an initial enquiry.

For technical studies undertaken by Evoenergy, the inputs required by the proponent are located in *Appendix E: Network Technical Study Information*. The fees and charges associated with the technical study are addressed in Section 6.

Technical studies will be assessed against the following criteria:

- 📁 Load flow parameters including power quality considerations and thermal loading
- 📁 Fault levels
- 📁 Protection coordination
- 📁 Connected generation type and capacity, load type and capacity and inverter specification to evaluate risk of islanded operation

The outputs of technical studies will include, but are not limited to the following:

- 📁 Assessment outcome specifying the approval or rejection of the application
- 📁 Export limitations where applicable
- 📁 Permitted maximum system capacity
- 📁 Additional network connection and Isolation points
- 📁 Site specific protection settings
- 📁 Inter-tripping requirements
- 📁 Power quality response requirements
- 📁 Detailed communications requirements
- 📁 Site specific operational requirements where applicable

Where the technical study results in the rejection of the application due to the assessment criteria, Evoenergy shall provide the proponent with justification and an alternative option which may include:

- 📁 Alternative configurations of the generating system (e.g. lower generation control limits)
- 📁 Network augmentation (and associated costs of network augmentation)

5. TESTING AND COMMISSIONING

All LV EG connections shall be subject to testing and commissioning prior to being placed in service. Table 19 specifies the required commissioning tests for each subcategory.

TABLE 19. TESTING AND COMMISSIONING REQUIREMENTS FOR LV EG CONNECTIONS

TESTING AND COMMISSIONING REQUIREMENTS	LV EG IES				LV EG Non-IES	
	≤ 200 KVA		> 200 KVA		Exporting	Non-Exporting
	Exporting	Non-Exporting	Exporting	Non-Exporting		
Protection Settings and Performance	✓	✓	✓	✓	✓	✓
Power Quality Settings and Performance	✓	✓	✓	✓	✓	✓
Export Limits Settings and Performance	✓	✓	✓	✓	✓	✓
Communications Settings and Performance	✗	✗	✓	✗	✓	✓
Shutdown Procedures	✓	✓	✓	*	✓	✓
Confirm System is as per specifications (Including Isolation Point)	✓	✓	✓	✓	✓	✓
Confirm System Documentation	✓	✓	✓	✓	✓	✓

The symbols used to denote the above requirements have the following meanings:

- ✓ Shall be required
- * May be required
- ✗ Shall not be required

The following requirements shall be met when performing testing and commissioning on LV EG connections:

- 📁 Testing and commissioning plans shall be produced by the proponent and submitted to Evoenergy prior to finalising the connection
- 📁 Prior to performing testing and commissioning, the installation shall also be approved for connection by the ACT Government Electrical Inspectorate Certificate of Electrical Safety shall be completed with a copy provided to Evoenergy. Any additional requirements, including those specified by the Utilities Technical Regulation team, shall be addressed prior to connection.
- 📁 Evoenergy shall witness the testing and commissioning and provide approval prior to the connection of the LV EG to the network

- 📌 Testing and commissioning acceptance shall be performed and authorised by an Evoenergy-approved suitably qualified person
- 📌 For IES, commissioning requirements shall be in accordance with AS/NZS 4777.1, AS/NZS 3000 and AS/NZS 5033 (where applicable), the equipment manufacturer's specifications and the Evoenergy technical requirements to demonstrate that the LV EG IES system meets the requirements of the connection agreement. Secondary settings shall be tested and proven through secondary injection
- 📌 For Non-IES, testing and commissioning requirements shall be in accordance with the equipment manufacturer's specifications and the Evoenergy technical requirements to demonstrate that the LV EG non-IES system meets the requirements of the connection agreement. Secondary settings shall be tested and proven through secondary injection
- 📌 All tests shall be installation tests, not type tests

The proponent shall submit notification to Evoenergy upon successful commissioning of the system as outlined on the Evoenergy [website](#).

6. FEES AND CHARGES

The following fees and charges for a LV EG connection are specified in the Evoenergy schedule of charges available on the Evoenergy [website](#):

- 📌 Connection Enquiry Processing Charges
- 📌 Network Technical Study Charges
- 📌 Contract Administration and Testing

All fees are specified by system class, where the class of EG systems are outlined in Table 20.

TABLE 20. CHARGING CLASS TABLE

SYSTEM FEE CLASS	SYSTEM CAPACITY
Class 1	≤ 30 kVA
Class 2	Exceeding 30 kVA and less than 60 kVA
Class 3	From 60 kVA and less than 120 kVA
Class 4	From 120 kVA and less than 200 kVA
Class 5	From 200 kVA and less than 1500 kVA
Class 6	From 1500 kVA up to 5000 kVA

In addition to the application charges, the system may be subject to Network Connection Charges will typically consist of the following items (where applicable):

- 📌 Network augmentation and design work
- 📌 Project management
- 📌 Communication Installation
- 📌 Inter-trip or Neutral Voltage Displacement installation

These will be calculated on a case-by-case basis and a quotation will be provided to the proponent.

In addition to the above, an ongoing operational fee is applicable for export-only LV EG connections as outlined in the Evoenergy schedule of charges located on the Evoenergy [website](#).

7. OPERATIONS AND MAINTENANCE

The LV EG system shall be operated and maintained to ensure compliance with the connection agreement and all legislation, codes and / other regulatory instruments at all times.

The generator shall be responsible for the following:

- 📄 Development of an operation and maintenance plan that will be provided to Evoenergy
- 📄 Maintaining the electrical installation at the supply address in a safe condition
- 📄 Providing operation and maintenance reports to Evoenergy on an annual basis
- 📄 Ensuring that any changes to the electrical installation at the supply address are performed by an electrician lawfully permitted to do the work and that the proponent holds a Certificate of Compliance issued in respect of any of the changes
- 📄 Seeking Evoenergy approval prior to altering the connection in terms of an addition, upgrade, extension, expansion, augmentation or any other kind of alteration, including changing inverter settings. These changes shall be tested, and the testing be witnessed by Evoenergy.
- 📄 For LV EG IES connections, perform periodic verification of the system every five years as per the periodic test procedure. The test declaration and test records forms can be accessed via the Evoenergy [website](#). The consumer shall maintain records of periodic tests and provide Evoenergy with a copy of the test results

If Evoenergy wish to inspect a system at any time, they may do so at no cost to the generator.

In the event a system is deemed to be non-compliant, Evoenergy will contact the generator in addition to the ACT Electrical Inspectorate and request that the system is rectified within a specified timeframe. If the generator fails to adequately address the non-compliance within the timeframe, Evoenergy will take steps to have the system disconnected from the network to ensure its obligations regarding the safe and reliable operation of the distribution system for operating personnel, customers and the general public are met. This process may vary depending on the severity of the safety risk posed by the system.

In the event of an inverter failure for a system with a fixed feed in tariff the generator shall replace the inverter with a compliant inverter with a generating capacity less than or equal to the failed inverter in accordance with the *Electricity Feed-in (Renewable Energy Premium) Act 2008*.

VERSION CONTROL

VERSION	DETAILS	APPROVED
1.0	Initial release version	W. Cleland – Asset Standards Mgr
1.1	Minor adjustments for final release	W. Cleland – Asset Standards Mgr
1.2	Minor adjustments and updated connection diagrams	W. Cleland – Asset Standards Mgr
1.3	Template change	W. Cleland – Asset Standards Mgr
1.4	Volt VAr/Watt - V1; 216 to 207	W. Cleland – Asset Standards Mgr
2.0	SCADA Requirements added and change to Section 4.5 Update document number from SM5062 to PO0844	W. Cleland – Asset Standards Mgr
2.1	Update of figures to have reference to new document number	M Lloyd – Customer Technical Services Manager

DOCUMENT CONTROL

DOCUMENT OWNER	PUBLISH DATE	REVIEW DATE
Customer Technical Service Manager	5 November 2020	5 November 2022

APPENDIX A – DEVIATIONS FROM THE NATIONAL DER CONNECTION GUIDELINES

TABLE 21. DEVIATIONS FROM THE NATIONAL DER CONNECTION GUIDELINES

SECTION	DESCRIPTION OF DEVIATION	TYPE OF DEVIATION	JUSTIFICATION
Introduction	Addition of subsections	Administrative	To improve ease of understanding and clearly state the context, scope, purpose obligations and compliance relevant to this document
Definitions and Abbreviations	Incorporation of System Capacity definition, amendment to Energy Storage System definition and addition of jurisdictional abbreviations and definitions	Administrative	To remove ambiguity in the interpretation and application of definitions throughout the document
Relevant Rules, Regulations, Standards and Codes	Addition of Evoenergy Documents subsection	Jurisdictional	Identification of jurisdictional documentation that is applicable to the Evoenergy network
Maximum System Capacity	Alteration of maximum system capacity to include ESS	Administrative	Alignment with the Micro EG connection system sizing capacity to promote improved benefits for proponents adding batteries to existing systems
Connection and Isolation	Inclusion to mandate the use of embedded networks for shared systems	Promote improved benefits to Australia's electricity system	Including this change will allow generators in shared complexes to uptake embedded generation
Inverter Integrated Protection	Active Anti-islanding	Administrative	Statement regarding Active Anti-islanding incorporated over table of set points to promote greater choice for proponents selecting compliant inverters
Islanding Protection	Permitted customer islanding operation	Promotes improved benefit to electricity system	Inclusion of customer islanded mode to specify requirements allowing proponents to safely retain supply during network outages
Central Protection	Alteration of table	Administrative	Correction of table to specify that reverse power protection and power factor protection is required for specified systems to promote increased level of clarity for proponents

Central Protection	Voltage and frequency set-points for Central protection relocated to Passive Anti-islanding protection table	Administrative	Values consolidated to a single table to provide an increased level of clarity for proponents
Grid Reverse Power Protection	Inclusion of setting limit	Administrative	Providing a setting limit enables an increased level of clarity for proponents
Passive Anti-islanding Protection	Set point values not provided for Non-IES systems	Jurisdictional	Passive set points for Non-IES systems will be specific to the type of generator used. Enabling the proponent to determine these values promotes an increased degree of application
Inter-tripping	Inclusion of Neutral Voltage Displacement protection	Jurisdictional	Allowing the application of NVD or conventional inter-trip promotes additional flexibility for proponents
Operating Voltage and Frequency	V_{nom_max} value relocated to the passive anti-islanding table	Administrative	Values consolidated to a single table to provide an increased level of clarity for proponents
Fees and Charges	Payment process not specified in this section	Administrative	The Evoenergy payment process is managed separately to the governance of LV EG PV connections. Proponents are able to seek clarity around this process during the application stage
Testing and Commissioning	Alteration of table	Administrative	Communications not required for some systems and is not able to be tested. Updated to enable increased clarity for proponents. Shutdown procedures are a requirement for all IES systems as per AS/NZS 4777.1
Operation and Maintenance	Inclusion of five yearly testing regime	Jurisdictional	This is an Evoenergy jurisdictional requirement
Operation and Maintenance	Inclusion of Feed in Tariff statement	Jurisdictional	The rate of failures within the ACT for inverter replacements on jurisdictional FiT tariffs requires clear direction on how the technical replacement of these systems shall be achieved
Appendix D	Appendix links to Evoenergy website to specify static data requirements	Administrative	Link to the application form specifying the data will enable independent update of the requirements with the establishment of the DER register
Appendix E	Inclusion of Appendix for NTS data	Administrative	Separate appendix specifying the information required to perform an NTS promotes an increased level of clarity for proponents
General	Removal of New Zealand settings from protection tables	Administrative	New Zealand values removed for ease of interpretation

APPENDIX B – CONNECTION ARRANGEMENT REQUIREMENTS

The figures in this Appendix display the common connections for Low Voltage Embedded Generators. Meters are not shown and the connections shall comply with retailers metering requirements. For additional information regarding connection arrangements please contact Evoenergy via the contact details listed on the [website](#).

Connection arrangements are shown for indication only with all loads shown as three phase for consistency. Actual connection arrangements are dependent on specific installation configurations.

FIGURE 3. LV EG IES CONNECTION TO MAIN SWITCHBOARD

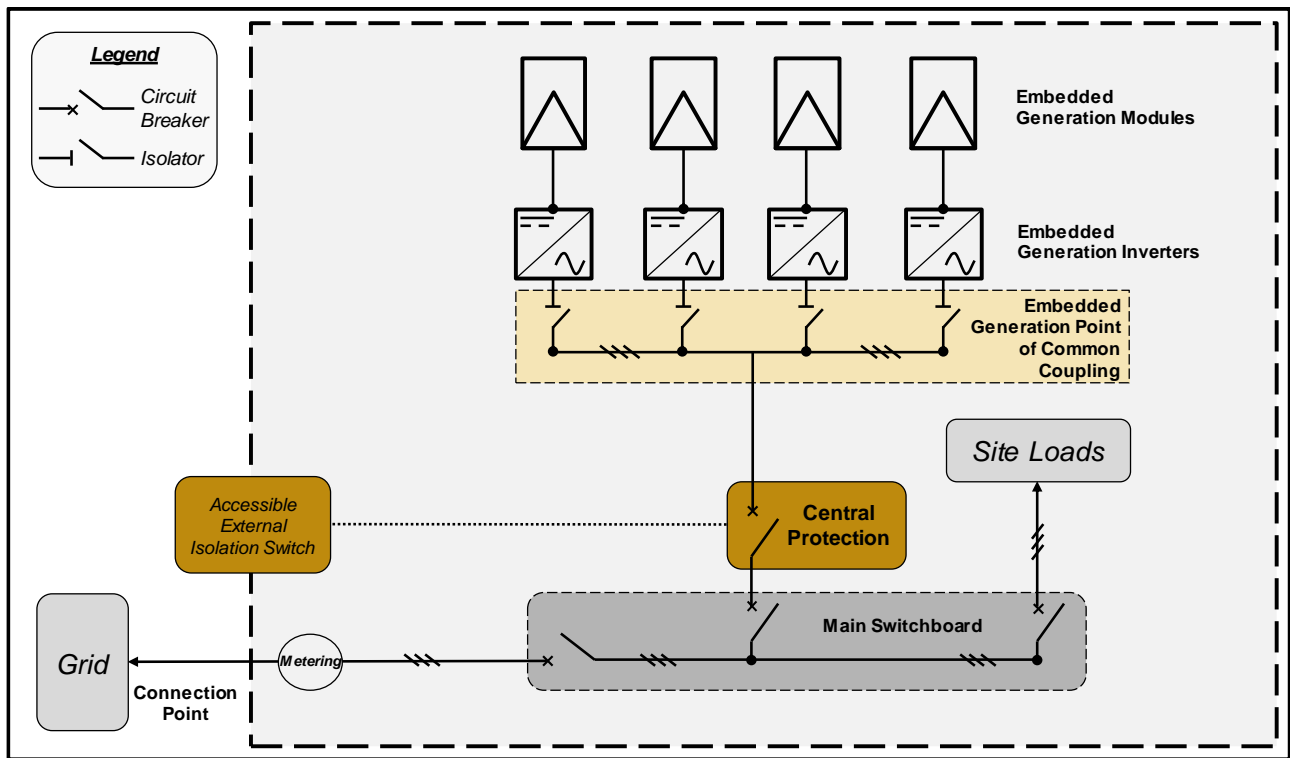

FIGURE 4. LV EG IES CONNECTION TO DISTRIBUTION BOARD

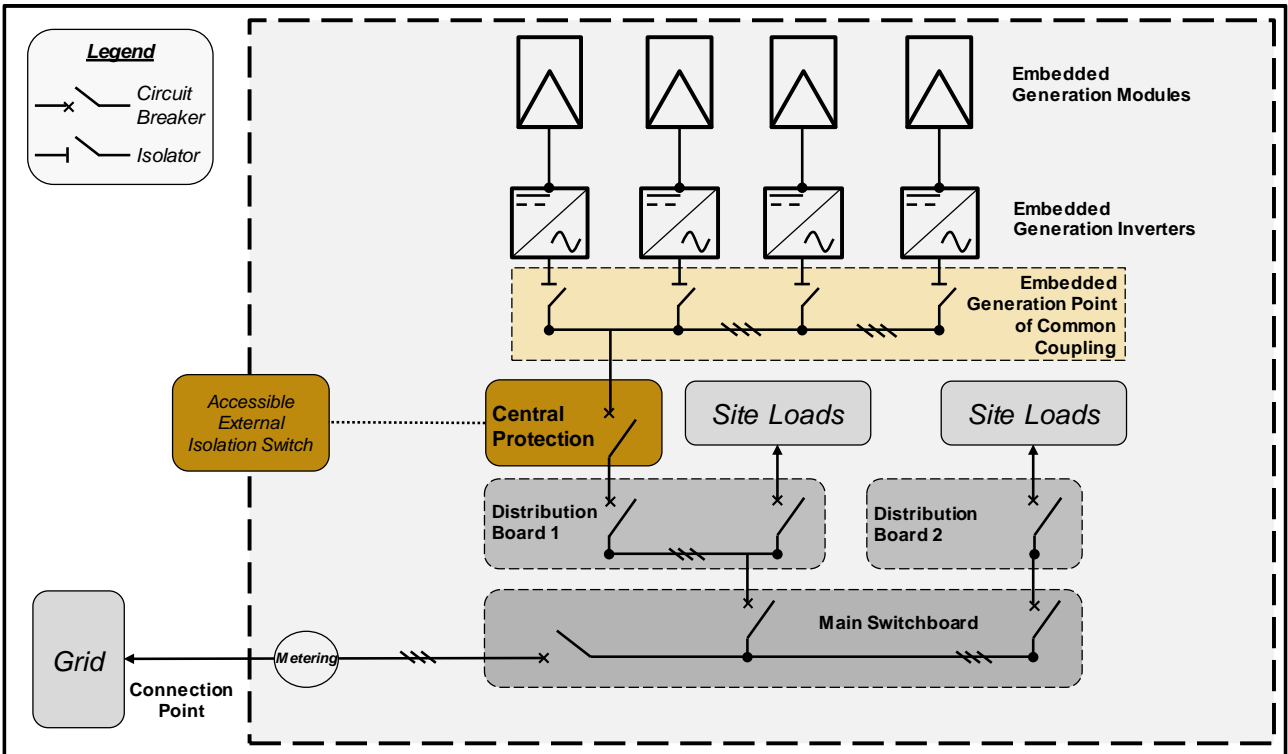

FIGURE 5. LV EG NON-IES CONNECTION TO MAIN SWITCHBOARD

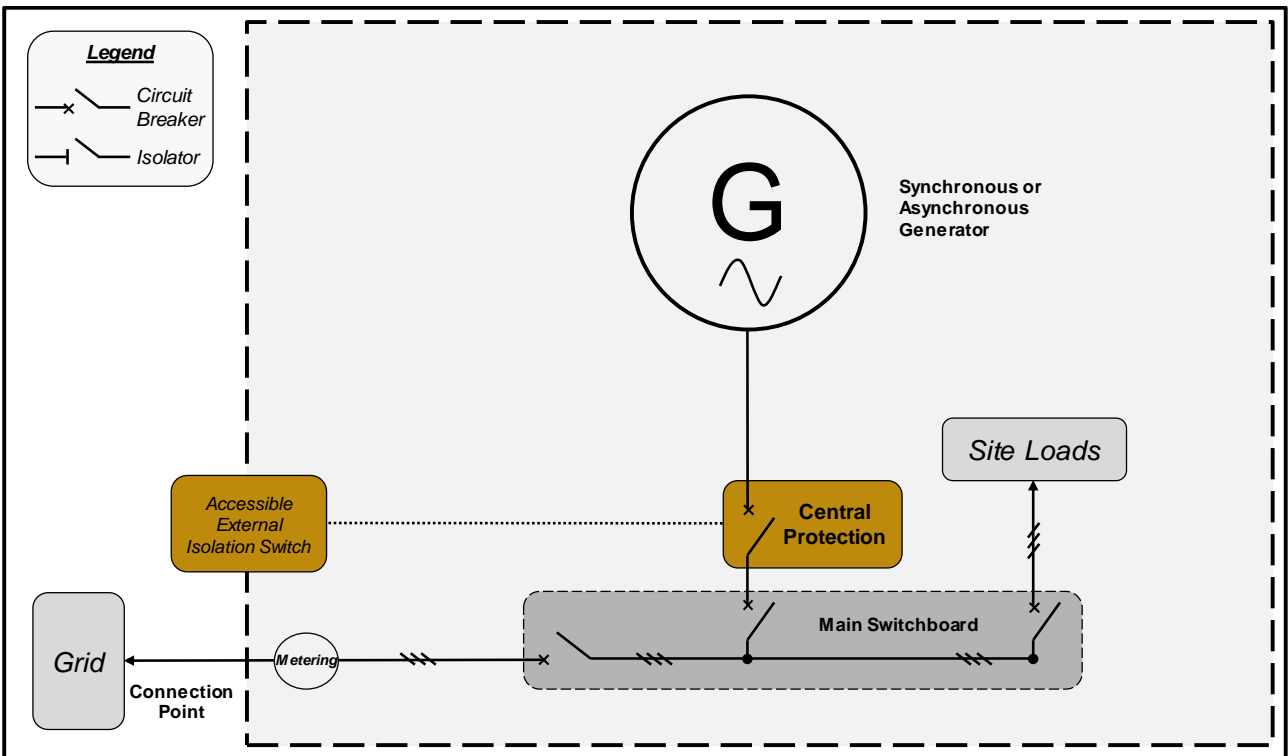
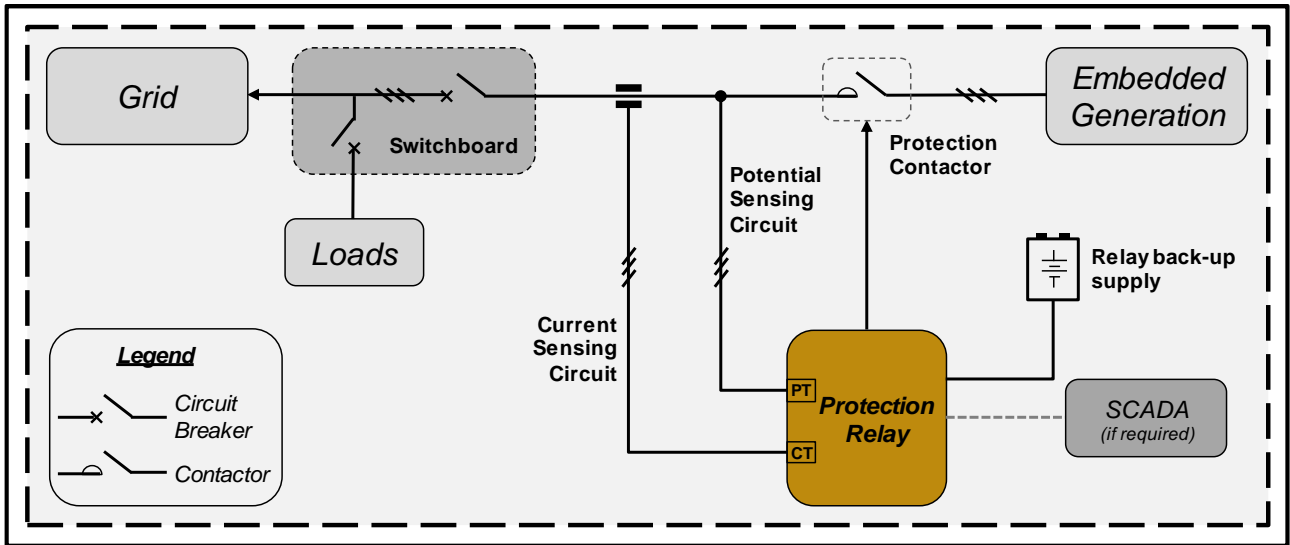

FIGURE 6. EXAMPLE ARRANGEMENT OF CENTRAL PROTECTION



Central protection settings can be found in Section 4.7.

APPENDIX C – MODEL STANDING OFFER

LV EG connections are administered through non-standard connection agreements. More information regarding connection agreements can be obtained by contacting Evoenergy through the contact details listed on the Evoenergy [website](#).

APPENDIX D – STATIC DATA AND INFORMATION

The static data requirements are outlined on the Embedded Generation application form available on the Evoenergy [website](#).

APPENDIX E – NETWORK TECHNICAL STUDY INFORMATION

The information required from the proponent for Evoenergy to perform a network technical study is outlined in the following table:

NETWORK TECHNICAL STUDY REQUIREMENT	DETAIL
Embedded Generation Application	A completed embedded generator application form is required for all generator connections as outlined in <i>Appendix D</i> .
Generator Description	<p>A description of the proposed embedded generating unit using the list below shall be provided by the proponent (where applicable):</p> <ul style="list-style-type: none"> ☞ Proposed operating mode(s) for systems, for example, peak lopping control regime, demand response regime, any storage strategies ☞ Proposed interaction with the Evoenergy distribution network under abnormal network conditions for example, network support operation and or customer islanded mode operation ☞ Details of any voltage control or power factor control strategies proposed ☞ Details of any energy storage capability ☞ Proposed local proponent loads to be supplied from the embedded generating unit where applicable ☞ Known future staging / development of the embedded generating system and / or local proponent loads
Generator Data	For Non-IES systems, the proponent shall provide a comprehensive list of technical generator data. For IES systems, Evoenergy may request information to confirm that the inverter is CEC accredited and / or meets Evoenergy requirements
Generation and Load Profiles	The proponent shall provide a generation and load profiles for the embedded generator, detailing the estimated load and generation behaviour on weekdays and weekends during summer and winter
Single Line Diagram	<p>The proponent shall provide detailed electrical single line diagram(s) which shall:</p> <ul style="list-style-type: none"> ☞ Be site specific ☞ Match what is submitted in the connection application <p>Single line diagrams shall show the configuration of all embedded generating unit(s) / proponent equipment with circuits between the generating unit(s) and the network connection point, including as a minimum:</p> <ul style="list-style-type: none"> ☞ All primary circuit equipment such as main switchboards, other switchboards, circuit breakers and isolators / load break switches. In particular, all points where the proponent embedded generating unit and the Evoenergy distribution network can be connected / disconnected must be clearly identified from end-to-end. It must be shown which phases the system will connect to ☞ All secondary protection and control equipment associated with the embedded generating unit's connection and parallel operation with the Evoenergy distribution network including, current transformers, voltage transformers, protection and control elements (using ANSI codes), SCADA and sensing points ☞ Local proponent load connections including any interconnections with other parts of the proponent's installation. In particular, where interconnection with other parts of the proponent's installation is proposed the means to prevent paralleling of Evoenergy substations / transformers and / or unsynchronised connection to the distribution network shall be clearly identified

	<ul style="list-style-type: none"> ☞ All metering equipment associated with the embedded generating unit and the import and export of power from / to the Evoenergy distribution network ☞ All proposed power factor correction equipment that will be installed within the part of the proponent's installation that is supplied directly from the embedded generating unit
Protection Information	<p>The proponent shall provide a functional block / schematic diagram of the protection and control systems relevant to the embedded generating unit's connection to the Evoenergy distribution network which includes an in-depth technical philosophy of the protection and control systems including:</p> <ul style="list-style-type: none"> ☞ All relevant relay current circuits ☞ Relay potential circuits ☞ Alarm and monitoring circuits ☞ Back-up systems ☞ Auxiliary power supply systems and ☞ Proposed parameters / settings of all protection and control system elements
Site Plan	<p>The proponent shall provide a detailed site plan specifying the system layout, proponent main switchboard and clearly identifying the system isolation point</p>
Communications Information	<p>For systems requiring communications, the proponent shall provide the following:</p> <ul style="list-style-type: none"> ☞ A drawing indicating all SCADA connections including provision for Evoenergy communications equipment ☞ A proposed index of I/O points ☞ Anticipated commissioning date